



SECRET JARDIN

---

**PRODUCT PRESENTATION  
2023**





**DUCTING FLANGE : GROW TENTS**



**SOCKS : GROW TENTS**



**LIGHTING**



**VENTILATION**



**GROW TENTS BUNDLES**



**ACCESSORIES**



**SPARE PARTS**

# secret JARDIN

## DARK STREET R4.00



**DS60** 2' x 2' x 62"  
**DS120W** 4' x 2' x 70"  
**DS90** 3' x 3' x 70"  
**DS150W** 5' x 2½' x 79"  
**DS120** 4' x 4' x 79"

Ø0.63" - M210D - DF16

## DARK ROOM R4.00



**DR150** 5' x 5' x 85"  
**DR240W** 8' x 4' x 79"  
**DR300W** 10' x 5' x 85"  
**DR240** 8' x 8' x 79"  
**DR300** 10' x 10' x 85"

Poles Ø1.00" - Mylar M400D - Techno DF25

## INTENSE R4.00



**INT480** 16' x 10' x 92"  
**INT600** 20' x 12' x 92"

Ø1.00" - M900D - DF25/DFM315

## DARK PROPAGATOR R4.00



**DP60** 2' x 1½' x 24"  
**DP90** 3' x 2' x 39"

Poles Ø0.63" - Mylar M210D - Techno DF16



**DP120** 4' x 2' x 76"

## LODGE R4.00



**L100** 3½' x 2' x 62"

Poles Ø0.63" - Mylar M210D - Techno DF16



**L160** 5¼' x 4' x 78"

## HYDRO SHOOT (SMALL) R2.00



**HS40** 1½' x 1½' x 47"  
**HS60** 2' x 2' x 62"  
**HS80** 2½' x 2½' x 70"

Poles Ø0.63" - Mylar M210D - Socks

## HYDRO SHOOT (LARGE) R2.00

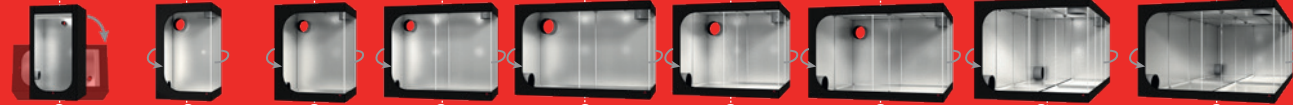

**HS100** 3½' x 3½' x 78"  
**HS120** 4' x 4' x 79"  
**HS150** 5' x 5' x 79"  
**HS240W** 8' x 4' x 79"  
**HS300W** 10' x 5' x 79"  
**HS240** 8' x 8' x 79"  
**HS300** 10' x 10' x 79"  
**HS480W** 16' x 8' x 79"  
**HS600W** 20' x 10' x 79"

Poles Ø0.75" - Mylar M210D - Socks

### DUCTING FLANGE



### SOCKS



2 ft<sup>2</sup>

7 ft<sup>2</sup>

11 ft<sup>2</sup>

25 ft<sup>2</sup>

50 ft<sup>2</sup>

100 ft<sup>2</sup>

200 ft<sup>2</sup>

Surface





# SECRET JARDIN VS HYDRO SHOOT

DIFFERENT FEATURES, SAME HIGH QUALITY!



## DUCTING FLANGE

(SECRET JARDIN)



Ducting Flange



Light Baffle



Connectors



Cable Flange



PatchIT



Water Tray



Space Booster

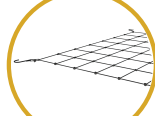

WebIT



CableIT



StrapIT



Handling

## SOCKS

(HYDRO SHOOT)



Cable Flange



Socks

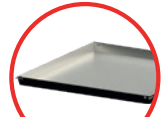

Water Tray



Handling

SAME HIGH END MATERIALS, SAME SPARE PARTS

DARK STREET R4.00

DARK ROOM R4.00

INTENSE R4.00



DS60 DS120W DS90 DS150W DS120 DR150 DR240W DR300W DR240 DR300 INT480 INT600

## DARK STREET



**Ducting Flange DF16**  
Connector: Ø4" – 5" – 6"

MYLAR 210D



**Q195 Steel**  
Ø0.63" – 0.75"



**Opening 270°**  
Full plant access



**Fully Pre-equipped**  
Adapt to your needs

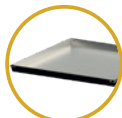

**Water tray**  
Strong & Removable



**100% Lightproof**  
Double-flap zip

## DARK ROOM



**Ducting Flange DF25**  
Connector: Ø6" – 6½" – 8" – 10"

MYLAR 400D



**#201 Stainless Steel**  
Ø1.00"



**Accessibility 360°**  
Front Rear & Side



**Fully Pre-equipped**  
Adapt to your needs

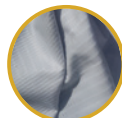

**Fibered Liner**  
Strong & Removable



**100% Lightproof**  
Double-flap zip

## INTENSE



**Ducting Flange DF25 & Ducting Flange Mobile DFM315**  
Connector: Ø6" – 6½" – 8" – 10"

MYLAR 900D



**#201 Stainless Steel**  
Ø1.00"

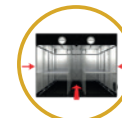

**Accessibility +360°**  
Full plant access



**Fully Pre-equipped**  
Adapt to your needs

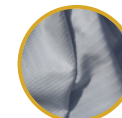

**Fibered Liner**  
Strong & Integrated



**Fully Linkable**  
Side & Front



DP60



DP90



DP120

## DARK PROPAGATOR



Ducting Flange DF16  
Connector : Ø4" – 5" – 6"

MYLAR 210D

DP90 : GRID IN OPTION



Q195 Steel  
Ø0.63"



Removable shelves  
Option in DP90



Fully Pre-equipped  
Adapt to your needs

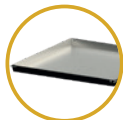

Water tray  
Strong & Removable

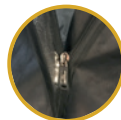

100% Lightproof  
Double-flap zip



L100



L160

## LODGE



Ducting Flange DF16  
Connector : Ø4" – 5" – 6"

MYLAR 210D

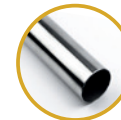

Q195 Steel  
Ø0.63" – 0.75"



1 Extractor/3 Rooms  
Full plant access



Fully Pre-equipped  
Adapt to your needs

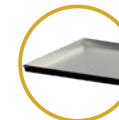

Water tray  
Strong & Removable

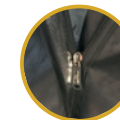

100% Lightproof  
Double-flap zip



## SMALL HYDRO SHOOT



SOCKS

MYLAR 210D



Q195 Steel  
Ø0.63"

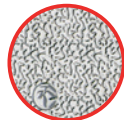

Reflective Mylar  
M210D



High & Small Plants  
Vertical or Horizontal

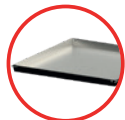

Water tray  
Strong & Removable



100% Lightproof  
Double-flap zip

## LARGE HYDRO SHOOT

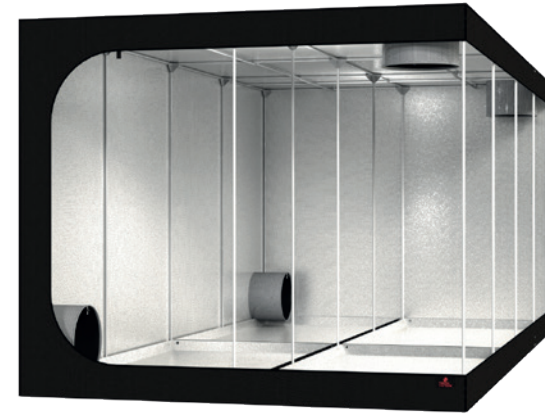

SOCKS

MYLAR 210D



Q195 Steel  
Ø0.75"

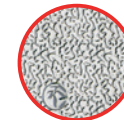

Reflective Mylar  
M210D

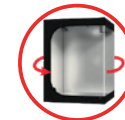

Opening 270°  
Full plant access

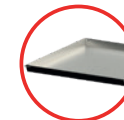



Water tray  
Strong & Removable

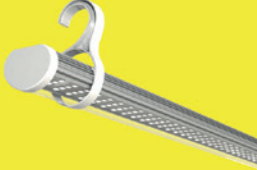

100% Lightproof  
Double-flap zip

# LIGHTING : PRODUCT POSITIONNING

		
	<b>COSMORROW LED</b>	<b>TLED</b>
<b>TECHNOLOGIE</b>	LED	LED
<b>APPLICATION</b>		
<b>INVESTMENT</b>	\$\$	\$\$\$
<b>CONSUMPTION</b>	\$	\$
<b>DURABILITY</b>	COL ★★☆☆☆ COP ★★★★★	★★★★☆

## LIGHT LEVEL VS GROW STAGE

LEVEL I			LEVEL II			LEVEL III				
0-100	100-200	200-300	300-400	400-500	500-600	600-800	800-1000	1000-1200	1200-1400	1400+
EARLY SPRING SUNLIGHT			SPRING SUNLIGHT			SUMMER SUNLIGHT				
Cutting, Seedling, Vegetative			Growing			Blooming				

P.P.F.D =  $\mu\text{mol/s/m}^2$



# COSMORROW TECHNOLOGY

Compact, solid, water proof, durable, safe (24V)



1. COSMORROW KITS FULL SPECTRUM



2. COSMORROW TNOLED GROW SPECTRUM



3. COSMORROW BOOSTERS UV & IR



4. COSMORROW BULBS & POWER SUPPLIES

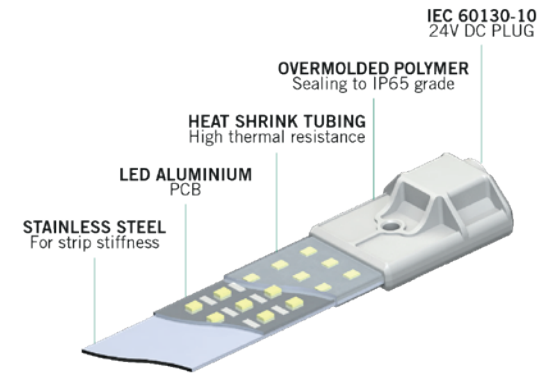

Patent n°W02021176302



**IP65**  
Waterproof



**Strong**  
Fall resistant



**24V Bulbs**  
100% Safe



**Custom**  
Spectrum

# COSMORROW KITS : FULL SPECTRUM

## SUMMER SUNLIGHT



**COM60K**



**COM100K**



REFERENCE	DESIGNATION	POWER	GROW AREA	PPE	PPF	PPFD AVERAGE*	BULBS INCULDED	COLOR / LINE	SPECTRUM
<b>COM60K</b>	Cosmorrow 60W FULL SPECTRUM	60W	2'x 1½'	2.4 µmol/s/W	144 µmol/s	765 µmol/s/m <sup>2</sup>	3x COP20BL		
<b>COM100K</b>	Cosmorrow 100W FULL SPECTRUM	100W	2'x 2'	2.4 µmol/s/W	240 µmol/s	728 µmol/s/m <sup>2</sup>	5x COP20BL		

\* d=6"

# COSMORROW KITS : 200 – 280 – 360 W\* FULL SPECTRUM

## SUMMER SUNLIGHT



**COM200FS**



**COM200FS + 1x UPGRADE 80W : 280W\***



**COM200FS + 2x UPGRADE 80W : 360W\***



REFERENCE	DESIGNATION	POWER	GROW AREA	PPE (bulb)	PPF	PPFD AVERAGE*2	BULBS INCULDED	COLOR / LINE	SPECTRUM
<b>COM200FS</b>	Cosmorrow 200W FULL SPECTRUM	200W	2½' x 2½'	2.85 µmol/s/W	540 µmol/s	1122 µmol/s/m <sup>2</sup>	5x COP40FS		
	+1x UPGRADE 80W	280W	3' x 3'	2.85 µmol/s/W	756 µmol/s	1108 µmol/s/m <sup>2</sup>	7x COP40FS		
	+2x UPGRADE 80W	360W	3½' x 3½'	2.85 µmol/s/W	972 µmol/s	1101 µmol/s/m <sup>2</sup>	9x COP40FS		

\* UPGRADE 80W (sold separately)

**COP40FS** x2 Cosmorrow LED 40W L36" FULL SPECTRUM

**COM40** x2 Cosmorrow Power 1x40W (Alternative: 1x COM2X40)

\*2 200W : d=8" / 280W : d=10" / 360W : d=12"



# COSMORROW TNOLED : GROW SPECTRUM

## SPRING SUNLIGHT



REFERENCE	DESIGNATION	POWER	GROW AREA	PPE	PPF	PPFD AVERAGE*	INCLUDED BULBS	COLOR / LINE	SPECTRUM
<b>TN04065</b>	TNoled 2x20W GROWING	40W	2' x 1 1/3'	2.0 $\mu\text{mol/s/W}$	80 $\mu\text{mol/s}$	355 $\mu\text{mol/s/m}^2$	2x COL2065		
<b>TN08065</b>	TNoled 2x40W GROWING	80W	4' x 1 1/3'	2.0 $\mu\text{mol/s/W}$	160 $\mu\text{mol/s}$	363 $\mu\text{mol/s/m}^2$	2x COL4065	6500 K 6500 K 6500 K	

\* d=6"

# COSMORROW IR & UV BOOSTER (INFRARED & ULTRAVIOLET)



Add a UV or IR booster whenever needed with our single power supply. We recommend using it with a timer separate from the main lighting.

- INFRARED**
- \* Trigger flowering
  - \* Heat up your plant
  - \* Longer internodes

- ULTRAVIOLET**
- \* Boost immune system
  - \* Fights mould
  - \* Shorter internodes

## BULBS

REFERENCE	DESIGNATION	PPF	COLOR / LINE	SPECTRUM	
<b>COL20IR</b>	Cosmorrow Led 20W L20 <sup>a</sup> IR	34 $\mu\text{mol/s}$	<p>2100 K    730 nm    2100 K</p>		<p>COL20IR</p>
<b>COL20UV</b>	Cosmorrow Led 20W L20 <sup>a</sup> UV	32 $\mu\text{mol/s}$	<p>6500 K    365 nm    6500 K</p>		<p>COL20UV</p>

## LIGHTING FIXTURE (EXC. BULB)

REFERENCE	DESIGNATION	POWER MAX
<b>COM20</b>	Cosmorrow Power 1x20W	20W





# COSMORROW BULBS & POWER SUPPLY

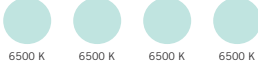
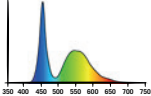

COP20BL

## BULBS

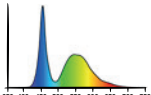
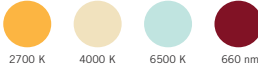
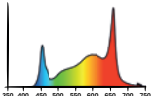
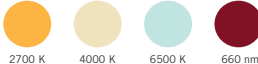
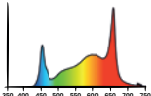
REFERENCE	DESIGNATION	PPE	PPF	COLOR / LINE	SPECTRUM
<b>COP2065</b>	Cosmorrow Led 20W L20" GROW	2.7 $\mu\text{mol/s/W}$	54 $\mu\text{mol/s}$	 6500 K 6500 K 6500 K 6500 K	
<b>COL4065</b>	Cosmorrow Led 40W L36" GROW	2.0 $\mu\text{mol/s/W}$	80 $\mu\text{mol/s}$	 6500 K 6500 K 6500 K	
<b>COP20BL</b>	Cosmorrow Led 20W L20" FULL SPECTRUM	2.4 $\mu\text{mol/s/W}$	48 $\mu\text{mol/s}$	 2700 K 4000 K 6500 K 660 nm	
<b>COP40FS</b>	Cosmorrow Led 40W L28" FULL SPECTRUM	2.85 $\mu\text{mol/s/W}$	114 $\mu\text{mol/s}$	 2700 K 4000 K 6500 K 660 nm	

## LIGHTING FIXTURE (EXC. BULB)

REFERENCE	DESIGNATION	POWER MAX
<b>COM20</b>	Cosmorrow Power 1x20W	20W
<b>COM40</b>	Cosmorrow Power 1x40W	40W



# TLED

A 50.000-HOUR LIFETIME



TLED4625



TLED2630

## BULBS

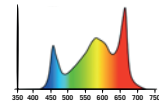
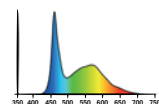
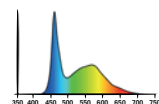
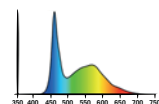
REFERENCE	DESIGNATION	PPE	PPF	SPECTRUM
<b>TLED2630</b>	TLED 26W L21" FULL SPECTRUM	2.0 $\mu\text{mol/s/W}$	52 $\mu\text{mol/s}$	
<b>TLED4230</b>	TLED 42W L38" FULL SPECTRUM	2.0 $\mu\text{mol/s/W}$	84 $\mu\text{mol/s}$	
<b>TLED2665</b>	TLED 26W L21" GROWING	2.0 $\mu\text{mol/s/W}$	52 $\mu\text{mol/s}$	
<b>TLED4265</b>	TLED 42W L38" GROWING	2.0 $\mu\text{mol/s/W}$	84 $\mu\text{mol/s}$	

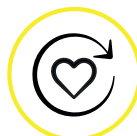
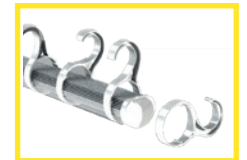
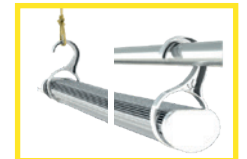

Durability



Easy to install



Compact

# VENTILATION

## 1. EXTRACTORS & FILTERS



## 2. DUCTING FLANGE

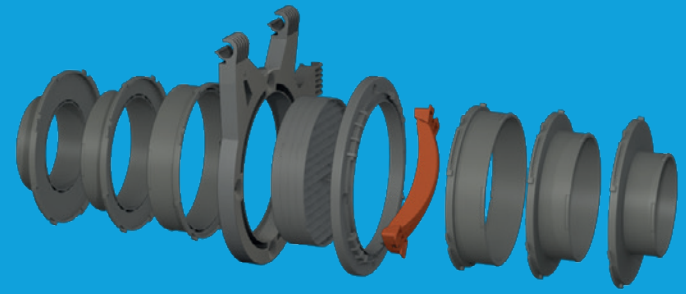

## 3. MONKEY FAN



# EXTRACTOR & FILTERS : LAYOUT



## DF16 EXTRACTORS

**DF16E150** DF16 – 30/60/90 cfm



**DF16E350** DF16 – 90/150/210 cfm



## DF16 FILTERS

**DF16F100**  
0.9 lb – 60 cfm



**DF16F150**  
2.0 lb – 90 cfm



**DF16F250**  
3.0 lb – 150 cfm



**DF16F350**  
4.0 lb – 210 cfm



## DF16 CONNECTORS

**DF16100** DF16 – Ø4"



**DF16 Technology**  
No tools needed

**DF16125** DF16 – Ø5"



**EC Motor**  
24V



**Max/Min Airflow**  
User controlled

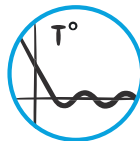

**Intelligent Speed Control**

**DF16150** DF16 – Ø6"



**High Quality Carbon**

## 2 THERMAL SENSORS

### CONFIGURATION 2

2<sup>nd</sup> THERMAL SENSOR

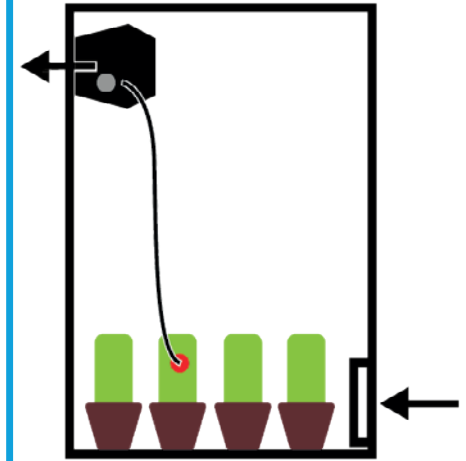

### CONFIGURATION 1

INTEGRATED SENSOR

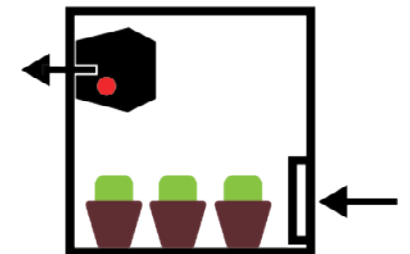

# EXTRACTOR & FILTERS



## CONNECT TO REGULAR DUCTING

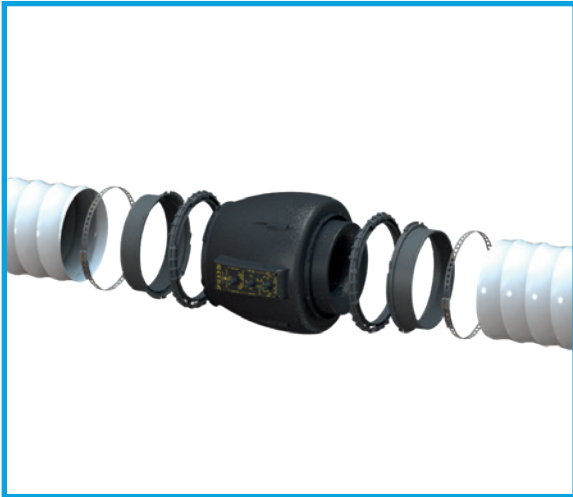

### EXAMPLES USING CONNECTORS



## CONNECT TO DUCTING FLANGE



### EXAMPLES WITH DUCTING FLANGE



### MALES : DEVICES

#### Extractor



#### Filter



#### Connector



### FEMALES : LINKS

#### Ducting Flange\*

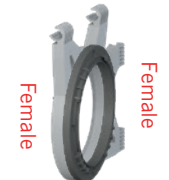

#### Ring\*\*



\* Includes a recess for Light Baffle  
 \*\* Extractors include two rings



# DUCTING FLANGE



## CONNECT SECRET JARDIN PERIPHERALS TO YOUR TENT



### DUCTING FLANGE

- DF16** Kit for 0.63" to 0.75" poles
- DF25** Kit for 1.00" poles



### EXTRACTOR

- DF16E350** DF16 Extractor T° 90/150/210 cfm
- DF16E150** DF16 Extractor T° 30/60/90 cfm

### FILTER

- DF16F100** DF16 Filter CTC80 0.9 lb 60 cfm
- DF16F150** DF16 Filter CTC80 2.0 lb 90 cfm
- DF16F250** DF16 Filter CTC80 3.0 lb 150 cfm
- DF16F350** DF16 Filter CTC80 4.0 lb 210 cfm

### CONNECTOR

For DF16 : Ø4" – Ø5" – Ø6"  
 For DF25 : Ø6" – Ø6½" – Ø8" – Ø10"

## CREATE PASSIVE INTAKES

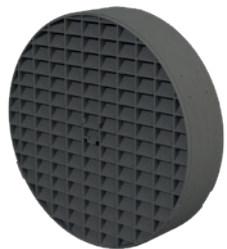

### LIGHT BAFLE

- DF16LB** DF16 Light Baffle with Mesh
- DF25LB** DF25 Light Baffle with Mesh

- Lightproof
- Increase your airflow or decrease your extraction needs
- Reduces stress on the tent
- Homogenize your tent atmosphere

### SINGLE INTAKE



### MULTIPLE INTAKES



## CREATE A Ø12" CONNECTION FLANGE



### DFM315K

### MOBILE DUCTING FLANGE Ø12"

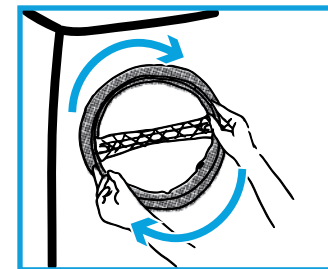

Cutting tool is included

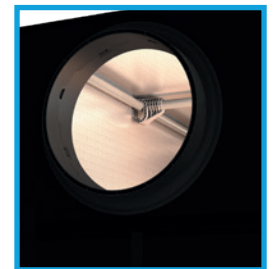

**Easy to install**  
On poles or tent fabric



**Choose your placement**  
Front, sides, backside, tent roof



**Robust Design**  
Supporting up to 6.5 lb



**Can be plugged up**  
PatchIT 16 & 25 (Spare Parts)



Cutting tool is included



**Through any flexible wall**  
Up to 0.1" thickness



**Easy to install**  
No screw needed



**Choose your placement**  
Front, sides, backside, tent roof



# MONKEY FAN

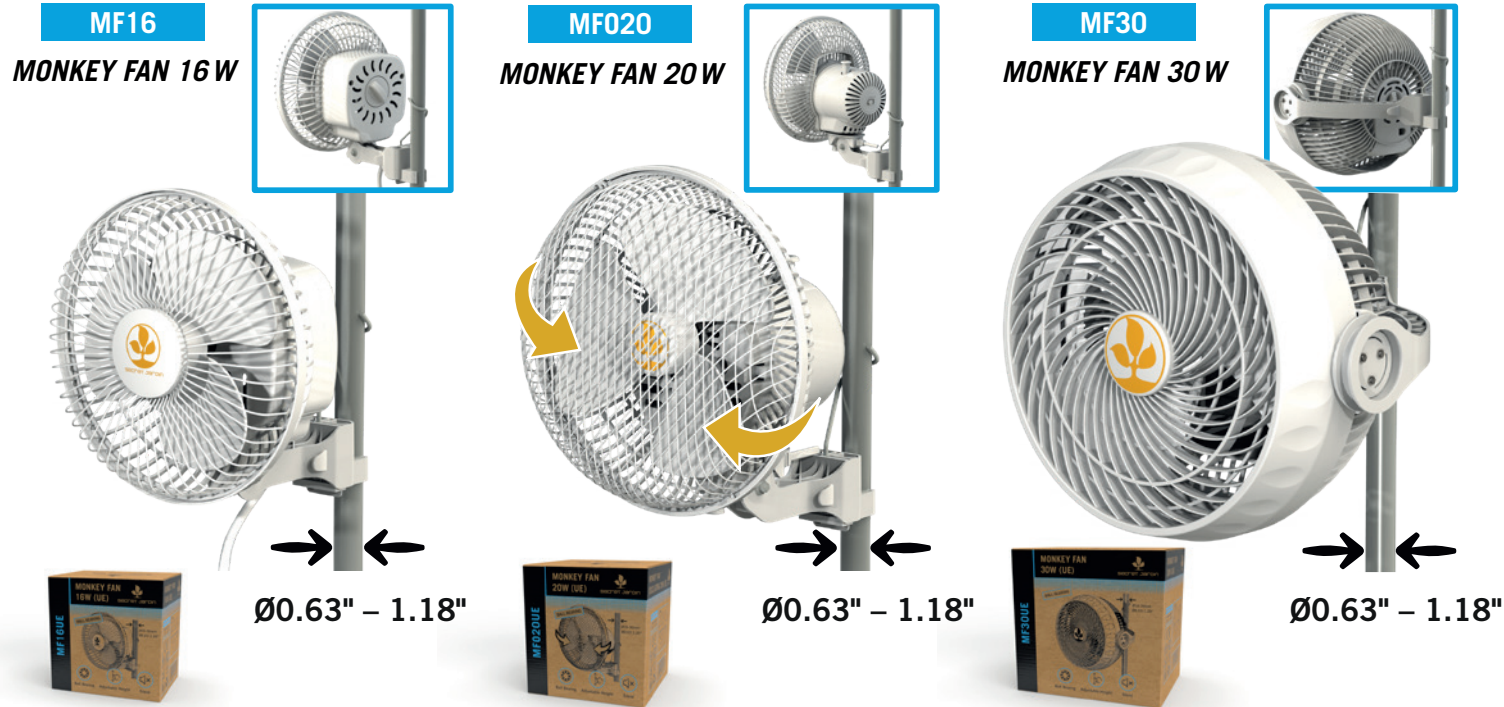

**CAUTION (MF020)**

**SPACE BOOSTER**

Space Booster

With Space Booster **YES**

Without Space Booster **NO**

**CABLE POSITION**

**YES**

**NO**

**DURABILITY IN CLEAN ENVIRONMENT (LIFE TIME)**

24/24 h = 6 months

12/24 h = 12 months

6/24 h = 24 months



Ball Bearing



Height Adjustable



Silent

# GROW TENTS BUNDLES



## 1. CLONING KITS



## 2. GROWING KITS



## 3. FULL SPECTRUM KITS



## GROW TENTS BUNDLES



### DP60CL

**CLONING KIT**  
2' x 1½' x 24"

The most compact solution for cloning application.

This bundle is made to fit one cloning tray. Easily maintain an high relative humidity thanks to the closed atmosphere.



### DP60GR

**GROWING KIT**  
2' x 1½' x 24"

Ideal space to host seedlings, cuttings or mother plants

This bundle is perfect to offer a complementary room to your setup. The early spring sunlight will fit all stage up to beginning of growing.



### DP90GR

**GROWING KIT**  
3' x 2' x 39"

Ideal bundle for seedlings, mother plants and growing stage

This bundle offers a 3' x 2' space ideal for growing. The height of the lamps can be adjusted to suit different heights of plants.

#	REFERENCE	DESIGNATION
1x	DP60	Dark Propagator 2' x 1½' x 24"
1x	COP2065	Cosmorrow Led 20W GROWING
1x	COM20	Cosmorrow Power 1x20W

#	REFERENCE	DESIGNATION
1x	DP60	Dark Propagator 2' x 1½' x 24"
1x	COP2065	Cosmorrow Led 20W GROWING
1x	COM20	Cosmorrow Power 1x20W
1x	DF16E150	DF16 Extractor T° 30/60/90 cfm
OPTION	DF16F100	DF16 Filter CTC80 0.9lb 60cfm

#	REFERENCE	DESIGNATION
1x	DP90	Dark Propagator 3' x 2' x 39"
2x	TN04065	TNoled 2x20W GROWING
1x	DF16E150	DF16 Extractor T° 30/60/90 cfm
OPTION	DF16F100	DF16 Filter CTC80 0.9lb 60cfm
OPTION	MF16BB	Monkey Fan 16W Ball Bearing

1x COP2065 – Average PPFD: 305µmol/s/m², d=6"

1x COP2065 – Average PPFD: 305µmol/s/m², d=6"

2x TN04065 – Average PPFD: 312µmol/s/m², d=6"



**Energy saving**  
LED technology



**24 V**  
100% Safe



**Closed environment**  
Easy high humidity



**Easy assembly**  
No tools required



**All in one**  
Light & Extraction included



**24 V**  
100% Safe



**Controlled atmosphere**  
Temperature



**Easy assembly**  
No tools required



**All in one**  
Light & Extraction included



**24 V**  
100% Safe



**Controlled atmosphere**  
Temperature



**Easy assembly**  
No tools required

# GROW TENTS BUNDLES



## DP120GR

**GROWING KIT**  
4'x2'x76"

Convert 7.5ft<sup>2</sup> into up to 32ft<sup>2</sup> of seedlings, cutting and mother plants all year round

Seedling, cutting, mother plant all in one tent for professional growers. Remove grids and reposition lamps to create higher spaces with higher light intensity.



## DS60FS

**FULL SPECTRUM KIT**  
2'x2'x62"

2'x2' full spectrum setup ideal for a whole cycle from seed to harvest

It will provide a summer sunlight to your plants (PPFD > 600). Remove LED strips to dim your lighting and create a growing stage setup.



## DS90FS

**FULL SPECTRUM KIT**  
3'x3'x70"

3'x3' full spectrum setup ideal for a whole cycle from seed to harvest

It will provide a summer sunlight to your plants (PPFD > 600). Remove LED strips to dim your lighting and create a growing stage setup or add optional COP40FS for higher intensity lighting.

#	REFERENCE	DESIGNATION
1x	DP120	Dark Propagator 4'x2'x75"
5x	COL4065	Cosmorrow Led 40W GROWING
5x	COM40	Cosmorrow Power 1x40W
1x	DF16E150	DF16 Extractor T° 30/60/90 cfm
OPTION	DF16F100	DF16 Filter CTC80 0.9lb 60cfm
OPTION	MF16BB	Monkey Fan 16W Ball Bearing

#	REFERENCE	DESIGNATION
1x	DS60	Dark Street 2'x2'x62"
1x	COM100K	Cosmorrow Kit 100W Full Spectrum
1x	DF16E150	DF16 Extractor T° 30/60/90 cfm
1x	DF16F150	DF16 Filter CTC80 2.0lb 90cfm
1x	MF16BB	Monkey Fan 16W Ball Bearing

#	REFERENCE	DESIGNATION
1x	DS90	Dark Street 3'x3'x70"
1x	COM200FS	Cosmorrow Kit 200W Full Spectrum
1x	DF16E350	DF16 Extractor T° 90/150/210cfm
1x	DF16F250	DF16 Filter CTC80 3.0lb 150cfm
1x	MF020BB	Monkey Fan 20W Osc. Ball Bearing

OPTION	UPGRADE 80 W :	
2x	COP40FS	Cosmorrow Led 40W Full Spectrum
2x	COM40	Cosmorrow Power 1x40W

1x COL4065 – Average PPFD: 120µmol/s/m<sup>2</sup>, d=6"

1x COM100K – Average PPFD: 728µmol/s/m<sup>2</sup>, d=6"

1x COM200FS – Average PPFD: 790µmol/s/m<sup>2</sup>, d=8"  
1x COM200FS + 1x UPGRADE 80W – Average PPFD: 1101µmol/s/m<sup>2</sup>, d=10"



All in one  
Light & Extraction included



24V  
100% Safe



Controlled atmosphere  
Temperature



Easy assembly  
No tools required



All in one  
Light & Extraction included



Full Spectrum  
Fits for full crop cycle



Controlled atmosphere  
Temperature



Easy assembly  
No tools required



All in one  
Light & Extraction included



Full Spectrum  
Fits for full crop cycle



Controlled atmosphere  
Temperature



Easy assembly  
No tools required

# GROW TENTS BUNDLES



## DS120WFS

**FULL SPECTRUM KIT**  
4'x2'x70"

4'x2' full spectrum setup ideal for a whole cycle from seed to harvest

This setup will provide a summer sunlight to your plants (PPFD > 600). Adjust the height of the 2 lighting systems separately to follow your plant growth. Remove LED strips to dim your lighting and create a growing stage setup.

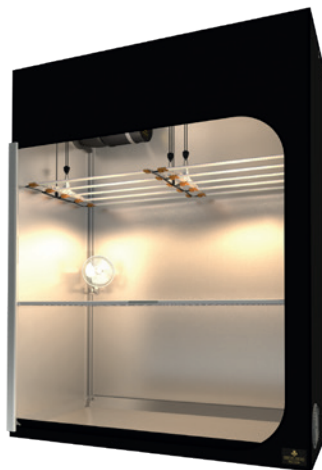

## DS150WFS

**FULL SPECTRUM KIT**  
5'x2½'x79"

5'x2½' full spectrum setup ideal for a whole cycle from seed to harvest

It will provide a summer sunlight to your plants (PPFD > 600). Adjust the height of the 2 lighting systems separately to follow your plant growth. Remove LED strips to dim your lighting and create a growing stage setup.



## L100FS

**FULL SPECTRUM KIT**  
3½'x2'x62"

Non-stop harvest with a 3x rooms tent: cutting & mother plant, growing and flowering

This bundle allows you to have 3 different grow stages in one tent. Light intensity and spectrum is dimensionned for each areas. Use only one extractor to control temperature in the whole tent thanks to the Ducting Flange system!

#	REFERENCE	DESIGNATION
1x	DS120W	Dark Street 4'x2'x70"
2x	COM100K	Cosmorrow Kit 100W Full Spectrum
1x	DF16E350	DF16 Extractor T° 90/150/210cfm
1x	DF16F250	DF16 Filter CTC80 3.0lb 150cfm
1x	MF020BB	Monkey Fan 20W Osc. Ball Bearing

#	REFERENCE	DESIGNATION
1x	DS150W	Dark Street 5'x2½'x79"
2x	COM200FS	Cosmorrow Kit 200W Full Spectrum
1x	DF16E350	DF16 Extractor T° 90/150/210cfm
1x	DF16F350	DF16 Filter CTC80 4.0lb 210cfm
1x	MF020BB	Monkey Fan 20W Osc. Ball Bearing

#	REFERENCE	DESIGNATION
1x	L100FS	Lodge 3½'x2'x62"
1x	COM100K	Cosmorrow Kit 100W Full Spectrum
1x	TN04065	TNoled 2x20W GROWING
1x	COP2065	Cosmorrow Led 20W GROWING
1x	COM20	Cosmorrow Power 1x20W
1x	DF16LB	DF16 Light Baffle with Mesh
1x	DF16E150	DF16 Extractor T° 30/60/90cfm
1x	DF16F150	DF16 Filter CTC80 2.0lb 90cfm
1x	MF16BB	Monkey Fan 16W Ball Bearing

2x COM100K – Average PPFD: 773µmol/s/m<sup>2</sup>, d=6"

2x COM200FS– Average PPFD: 1153µmol/s/m<sup>2</sup>, d=8"



**All in one**  
Light & Extraction included



**Full Spectrum**  
Fits for full crop cycle



**Controlled atmosphere**  
Temperature



**Easy assembly**  
No tools required



**All in one**  
Light & Extraction included



**Full Spectrum**  
Fits for full crop cycle



**Controlled atmosphere**  
Temperature



**Easy assembly**  
No tools required



**All in one**  
Light & Extraction included



**3 grow areas**  
Fits for full crop cycle



**Controlled atmosphere**  
Temperature



**Easy assembly**  
No tools required

1x COM100K – Average PPFD: 728µmol/s/m<sup>2</sup>, d=6"  
1x COP2065 – Average PPFD: 305µmol/s/m<sup>2</sup>, d=6"  
1x TN04065 – Average PPFD: 355µmol/s/m<sup>2</sup>, d=6"

# ACCESSORIES

## 1. DRYERS

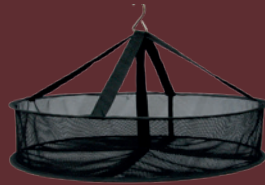

## 2. WEB PLANT SUPPORTS

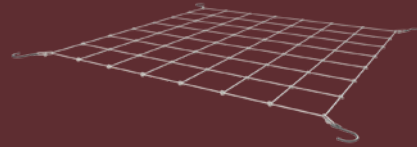

## 3. REMOVABLE WATER TRAY

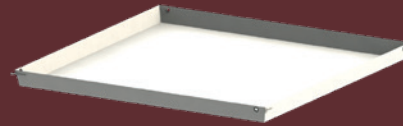

## 3. CABLES & WATER PIPES INSTALLATIONS



## 3. SUPPORT & REINFORCEMENT



## 6. TENT REPAIR KITS





# DRY IT



**DRYIT45**

*Ø18" LINKABLE*



**DRYIT90**

*Ø31" 5 LAYERS H63"*



# WEB PLANT SUPPORT

WEBTH: Thread / small sizes – WEBIT: Elastic / Large sizes



## WEBTH

THREAD WEB PLANT SUPPORT

## WEBIT

ELASTIC WEB PLANT SUPPORT

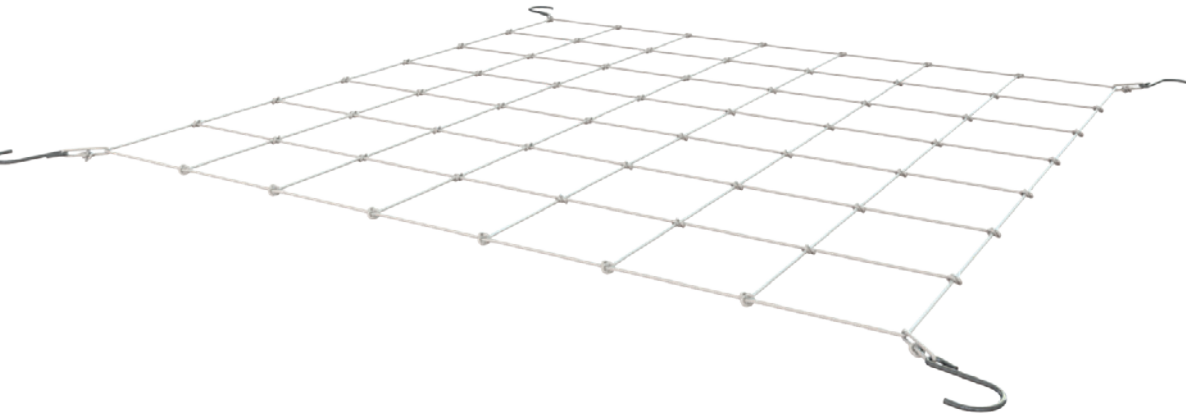

## WEBTH

THREAD

<b>WEBTH60</b>	<b>24" x 24"</b>
<b>WEBTH90</b>	<b>36" x 36"</b>
<b>WEBTH120</b>	<b>48" x 48"</b>
<b>WEBTH120W</b>	<b>48" x 24"</b>
<b>WEBTH150W</b>	<b>60" x 30"</b>

**Mesh Size**  
= 4" x 4"

## WEBIT

ELASTIC

<b>WEBIT120</b>	<b>48" x 48"</b>
<b>WEBIT150</b>	<b>60" x 60"</b>
<b>WEBIT240W</b>	<b>96" x 48"</b>
<b>WEBIT300W</b>	<b>120" x 60"</b>

**Mesh Size**  
≈ 5" x 5"





# REMOVABLE WATER TRAY

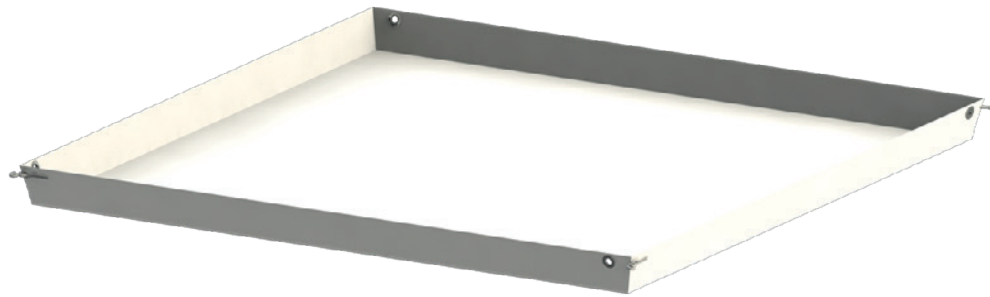

<b>WTL60</b>	<b><i>24"x24"x2"</i></b>
<b>WTL90</b>	<b><i>36"x36"x2"</i></b>
<b>WTL120</b>	<b><i>48"x48"x2"</i></b>
<b>WTL150</b>	<b><i>60"x60"x2"</i></b>

<b>WTL120W</b>	<b><i>48"x24"x2"</i></b>
<b>WTL150W</b>	<b><i>60"x30"x2"</i></b>
<b>WTL240W</b>	<b><i>96"x48"x2"</i></b>
<b>WTL300W</b>	<b><i>120"x60"x2"</i></b>

# CABLES & WATER PIPES INSTALLATIONS



**CABLEIT16**

**FOR POLE  
Ø0.63"**



**CABLEIT19**

**FOR POLE  
Ø0.75"**



**CABLEIT25**

**FOR POLE  
Ø1.00"**

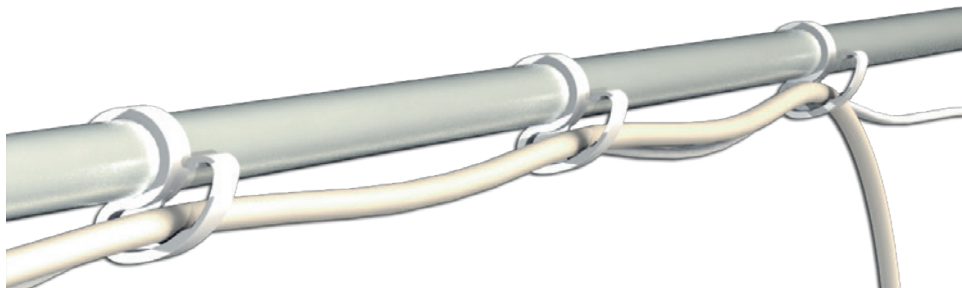

**FOR ALL GROW TENTS**

**CF7D**

**KIT CABLE FLANGE DOUBLE SOCKS**

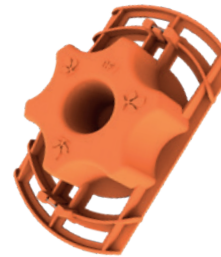

Fits anywhere



Can be plugged up  
PatchIT7 (Spare Parts)



Easy to install

# SUPPORTS & REINFORCEMENT



## SPACE BOOSTER

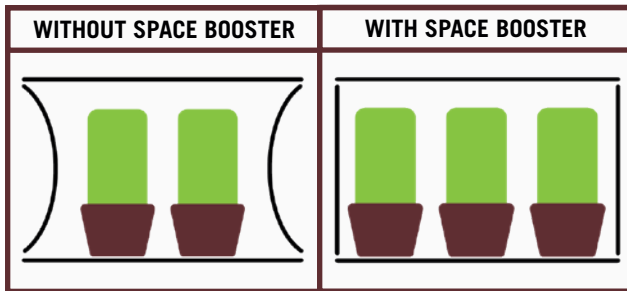
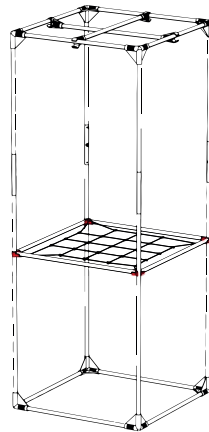
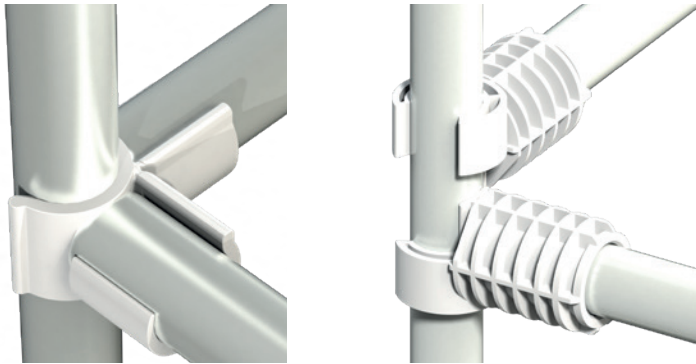

Up to 25% more space



Reinforces your tent



Supports the WebIT



Height Adjustable

## HANDLING

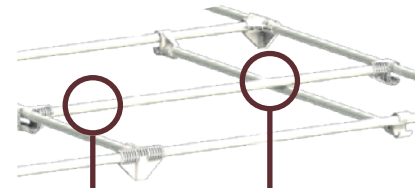

1 pole	2 cross poles	
20 lb max	40 lb max	Ø0.63"
30 lb max	60 lb max	Ø0.75"
50 lb max	100 lb max	Ø1.00"

### 2 CORNERS POSITIONS

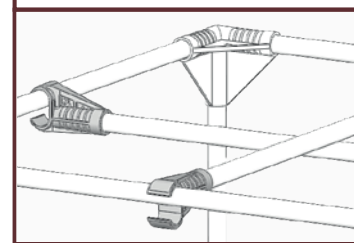

Solid holder



Secure Attachment  
Double hook system

## SUPPORT IT

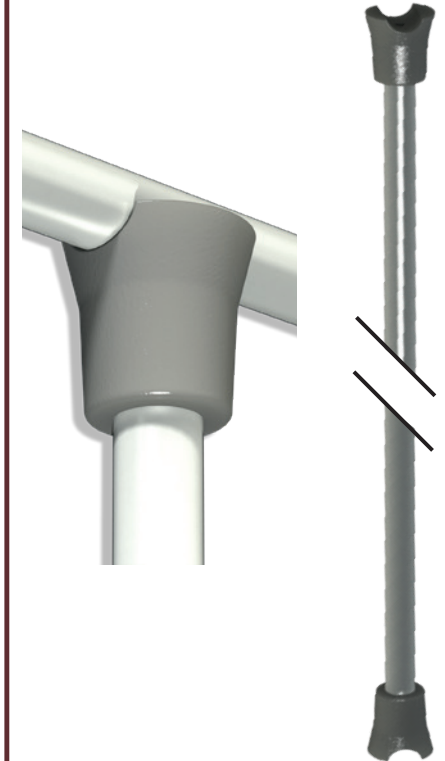

Easy set up



Reinforces your tent

# SUPPORTS & REINFORCEMENT



## DARK STREET

REF	DESIGNATION	STRUCTURE					HANDLING POLES INCLUDED					SPACE BOOSTER INCLUDED				
		DS60	DS90	DS120	DS120W	DS150W	DS60	DS90	DS120	DS120W	DS150W	DS60	DS90	DS120	DS120W	DS150W
T16-60	Pole Ø0.63" 22"	12			4		2					4			2	
T16-90	Pole Ø0.63" 34"		16		8			2				4			4	
T16-100	Pole Ø0.63" 38"	4														
T16-120	Pole Ø0.63" 46"				4				2						2	
T16-Link	Link Ø0.63"	4	4		4											
C16-Y	Corner Ø0.63" 3 axes Y shape	8	8		8											
C16-H	Handling Corner Ø0.63"						2	4		2						
C16-SB	Space Booster Ø0.63"										4	4			4	
T19-75	Pole Ø0.75" 28.6"					12								4		6
T19-100	Pole Ø0.75" 38.4"				8										8	
T19-120	Pole Ø0.75" 45.4"				8				2					4		
T19-Link	Link Ø0.75"				4									2		2
C19-Y	Corner Ø0.75" 3 axes Y shape				8										8	
C19-H	Handling Corner Ø0.75"								4					4		
C19-SB	Space Booster Ø0.75"													4		4

## DARK ROOM

REF	DESIGNATION	STRUCTURE					HANDLING POLES INCLUDED					SPACE BOOSTER INCLUDED						
		DR150	DR240	DR300	DR240W	DR300W	DR150	DR240	DR300	DR240W	DR300W	DR150	DR240	DR300	DR240W	DR300W		
T25-75	Pole Ø1.00" 28"	16		40		26	6			20		10		8		24		16
T25-100	Pole Ø1.00" 38"	4	18	9	12	6												
T25-120	Pole Ø1.00" 45"	4	20	9	13	6		9						12			8	
T25-Link	Link Ø1.00"	12	9	29	6	19	3		10				5	4		12		8
C25-Y	Corner Ø1.00" 3 axes Y shape	8	8	8	8	8												
C25-K	Corner Ø1.00" 4 axes K shape		4	4	2	2												
C25-T	Corner Ø1.00" 3 axes T shape		4	4	2	2												
C25-XI	Corner Ø1.00" 5 axes XI shape		1	1														
C25-H	Handling Corner Ø1.00"						6	18	20	10	10							
C25-SB	Space Booster Ø1.00"											8	24	24	16	16		
C25-RF	Rubber Feet Ø1.00"		1	1														

## HYDRO SHOOT (SMALL)

REF	DESIGNATION	STRUCTURE				HANDLING POLES INCLUDED			
		HS40	HS60	HS80	HS100	HS40	HS60	HS80	HS100
T16-40	Pole Ø0.63" 14"	8				2			
T16-60	Pole Ø0.63" 22"	8	8				2		
T16-80	Pole Ø0.63" 30"		8	8				2	
T16-90	Pole Ø0.63" 34"			8					
T16-100	Pole Ø0.63" 38"				16				2
T16-Link	Link Ø0.63"	4	4	4	4				
C16-Y	Corner Ø0.63" 3 axes Y shape	8	8	8	8				
C16-H	Handling Corner Ø0.63"					4	4	4	4

## HYDRO SHOOT (LARGE)

REF	DESIGNATION	STRUCTURE								HANDLING POLES INCLUDED							
		HS120	HS150	HS240	HS300	HS240W	HS300W	HS480W	HS600W	HS120	HS150	HS240	HS300	HS240W	HS300W	HS480W	HS600W
T19-75	Pole Ø0.75" 28.6"		16		40		26		72								20
T19-100	Pole Ø0.75" 38.4"	8	8	18	18	12	12	30	30								
T19-120	Pole Ø0.75" 45.4"	8		20		13		36		2		5		3		10	
T19-Link	Link Ø0.75"	4	12	9	29	6	19	15	51								10
C19-Y	Corner Ø0.75" 3 axes Y shape	8	8	8	8	8	8	8	8								
C19-K	Corner Ø0.75" 4 axes K shape			8	8	4	4	16	16								
C19-XI	Corner Ø0.75" 5 axes XI shape				1	1		4	4								
C19-H	Handling Corner Ø0.75"									4	4	10	10	6	6	20	20
C19-RF	Rubber Feet Ø0.75"				1	1											

## DARK PROPAGATOR

REF	DESIGNATION	STRUCTURE			HANDLING POLES		
		DP60	DP90	DP120	DP60	DP90	DP120
T16-40	Pole Ø0.63" 14"	4	4	20			
T16-60	Pole Ø0.63" 22"	8	8	6	1	2	
T16-90	Pole Ø0.63" 34"		6				
T16-120	Pole Ø0.63" 46"			12			1
C16-Y	Corner Ø0.63" 3 axes Y shape	8	8	8			
C16-K	Corner Ø0.63" 4 axes K shape			4			
C16-T	Corner Ø0.63" 3 axes T shape		4	12			
C16-H	Handling Corner Ø0.63"				2	2	2
GRID6040	GRID 24" x 16"	-	Option	12			

## LODGE

REF	DESIGNATION	STRUCTURE		HANDLING POLES INC.		SPACE BOOSTER INC.	
		L100	L160	L100	L160	L100	L160
T16-40	Pole Ø0.63" 14"	5	5				
T16-60	Pole Ø0.63" 22"	22		3		4	
T16-100	Pole Ø0.63" 38"	8	16				
T16-120	Pole Ø0.63" 46"		14		3		4
T16-Link	Link Ø0.63"	4					
C16-Y	Corner Ø0.63" 3 axes Y shape	16	16				
C16-K	Corner Ø0.63" 4 axes K shape	2	2				
C16-T	Corner Ø0.63" 3 axes T shape	2	2				
C16-H	Handling Corner Ø0.63"			6	6		
C16-SB	Space Booster Ø0.63"					4	4
GRID6040	GRID 24" x 16"	1	2				

## INTENSE

REF	DESIGNATION	STRUCTURE		HANDLING POLES INC.		SPACE BOOSTER INC.	
		INT480	INT600	INT480	INT600	INT480	INT600
T25-60	Pole Ø1.00" 24"	8	8				
T25-75	Pole Ø1.00" 28"		80		20		48
T25-120	Pole Ø1.00" 45"	80	40	10		24	
T25-Link	Link Ø1.00"	20	60		10		24
C25-Y	Corner Ø1.00" 3 axes Y shape	8	8				
C25-K	Corner Ø1.00" 4 axes K shape	12	12				
C25-T	Corner Ø1.00" 3 axes T shape	10	10				
C25-XI	Corner Ø1.00" 5 axes XI shape	6	6				
C25-H	Handling Corner Ø1.00"			20	20		
C25-SB	Space Booster Ø1.00"					48	48
C25-RF	Rubber Feet Ø1.00"	6	6				

# SUPPORTS & REINFORCEMENT



## CARRYIT

**BALLAST SUPPORT 5"x 14" 22 lb**

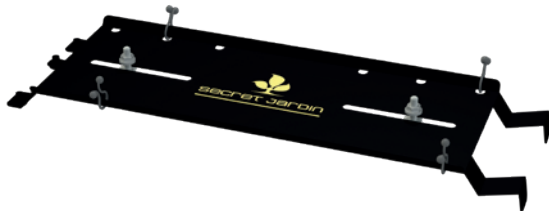

## BALLAST MAX

**Dimensions: 4½" x 14"**  
**Weight: 22 lb**

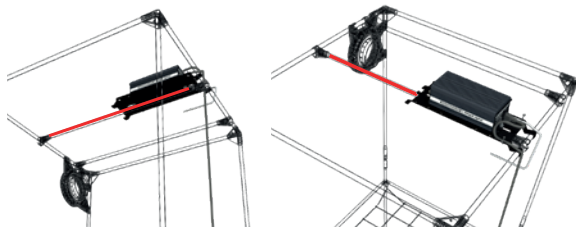

## GRID6040

**24" x 16"**

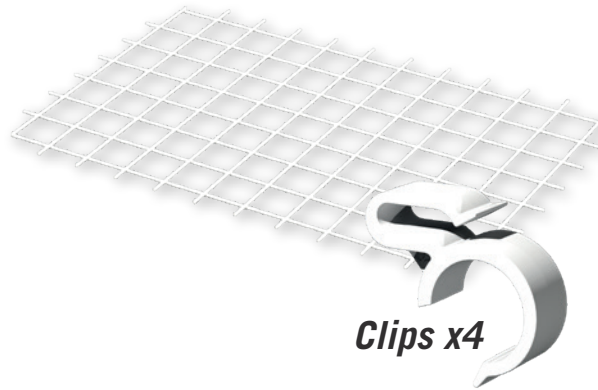

*Clips x4*

WITH OPTION GRID x1

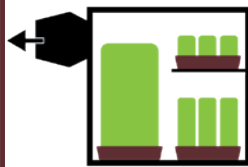

WITH OPTION GRID x2

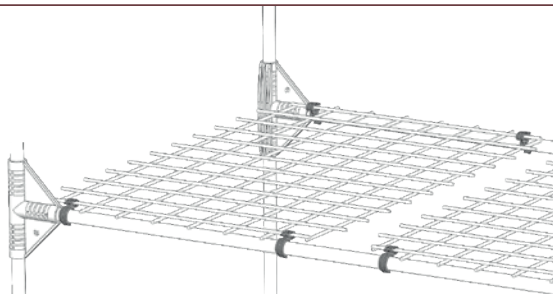
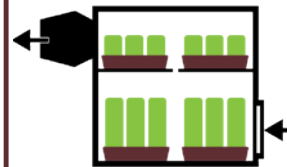

## STRAPIT45

**2x StrapIT**  
**Ø2"/66 lb each**

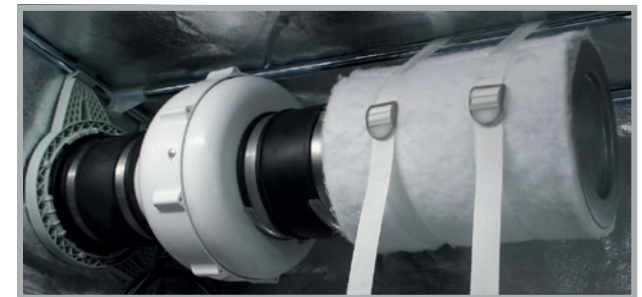



## TENT REPAIR KITS



### PATCHIT7

Ø4"

*PatchIT Mylar/Fabric (CF7D)*

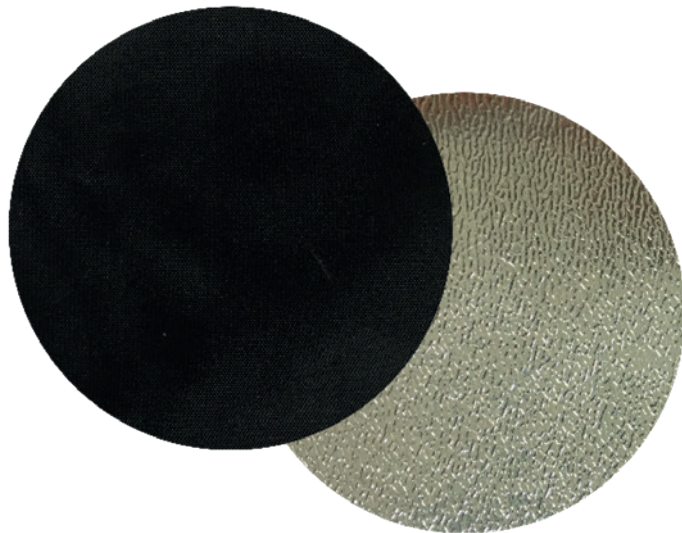

### PATCHIT16

Ø10"

*PatchIT Mylar/Fabric (DF16)*

### PATCHIT25

Ø14"

*PatchIT Mylar/Fabric (DF25)*



## SPARE PARTS : 36 parts for all SJ & HS tents



T16-40	14"
T16-60	22"
T16-80	30"
T16-90	34"
T16-100	38"
T16-120	46"

**POLES**  
Ø0.63"

**T16-LINK**  
**LINK**

**C16-Y**  
**CORNER 3 AXES**



**C16-T**  
**CORNER 3 AXES**



**C16-K**  
**CORNER 4 AXES**



**C16-XI**  
**CORNER 5 AXES**

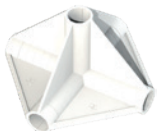

**C16-H**  
**HANDLING CORNER**



**C16-SB**  
**SPACE BOOSTER**



**C16-RF**  
**RUBBER FEET**



T19-75	28.6"
T19-100	38.4"
T19-120	45.4"
T19-LINK	LINK

**POLES**  
Ø0.75"

**C19-Y**  
**CORNER 3 AXES**



**C19-K**  
**CORNER 4 AXES**



**C19-XI**  
**CORNER 5 AXES**



**C19-H**  
**HANDLING CORNER**



**C19-SB**  
**SPACE BOOSTER**



**C19-RF**  
**RUBBER FEET**



T25-60	24"
T25-75	28"
T25-100	38"
T25-120	45"
T25-LINK	LINK

**POLES**  
Ø1.00"

**C25-Y**  
**CORNER 3 AXES**



**C25-T**  
**CORNER 3 AXES**



**C25-K**  
**CORNER 4 AXES**



**C25-XI**  
**CORNER 5 AXES**



**C25-H**  
**HANDLING CORNER**



**C25-SB**  
**SPACE BOOSTER**



**C25-RF**  
**RUBBER FEET**



